

SOURCE SIDE

PIN NO.	PIN NAME
1	ML_Lane 0 (p)
2	GND
3	ML_Lane 0 (n)
4	ML_Lane 1 (p)
5	GND
6	ML_Lane 1 (n)
7	ML_Lane 2 (p)
8	GND
9	ML_Lane 2 (n)
10	ML_Lane 3 (p)
11	GND
12	ML_Lane 3 (n)
13	CONFIG1
14	CONFIG2
15	AUX CH (p)
16	GND
17	AUX CH (n)
18	Hot Plug Detect
19	Return
20	DP_PWR

SINK SIDE

PIN NO.	PIN NAME
1	ML_Lane 3 (n)
2	GND
3	ML_Lane 3 (p)
4	ML_Lane 2 (n)
5	GND
6	ML_Lane 2 (p)
7	ML_Lane 1 (n)
8	GND
9	ML_Lane 1 (p)
10	ML_Lane 0 (n)
11	GND
12	ML_Lane 0 (p)
13	CONFIG1
14	CONFIG2
15	AUX CH (p)
16	GND
17	AUX CH (n)
18	Hot Plug Detect
19	Return
20	DP_PWR

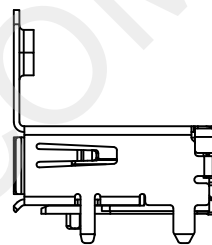
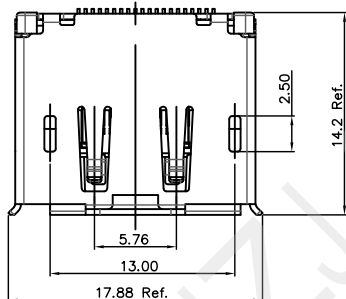
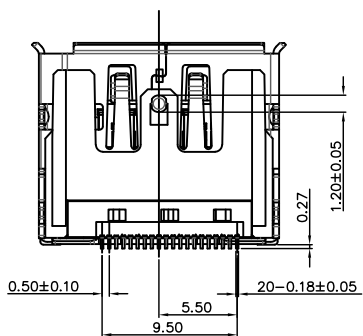

MATERIALS

- HOUSING : LCP (UL94V-0) , BLACK.
- TERMINAL : COPPER ALLOY, T=0.15mm  
GOLD PLATED ON CONTACT AREA.  
MATTE TIN PLATED ON SOLDER TAIL,  
UNDER NICKEL PLATED.
- SHELL : BRASS, T=0.40mm, 50u" MIN NICKEL PLATED.

SPECIFICATION

- CURRENT RATING : 0.5A .
- DIELECTRIC WITHSTANDING VOLTAGE :  
500V AC R.M.S. FOR ONE MINUTE.
- INSULATION RESISTANCE : 100MΩ MIN. AT 500V DC.
- CONTACT RESISTANCE : 30mΩ MAX.
- OPERATING TEMPERATURE : -25°C TO +85°C.
- DURABILITY : 10000 CYCLES.
- MATING FORCE : 4.5kgf MAX.
- UNMATING FORCE : 1.0kgf MIN.

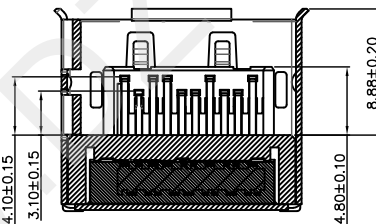
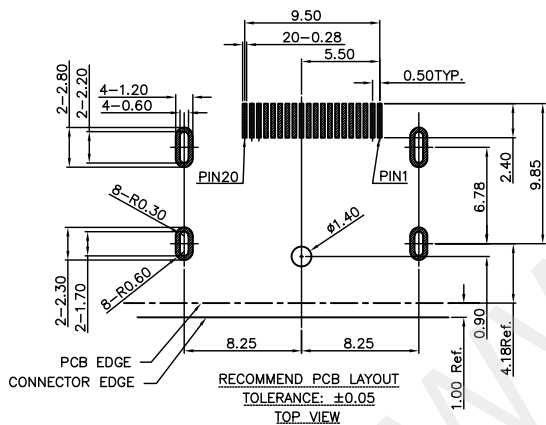

**深圳市华宇创精密电子有限公司**

 TOLERANCE: X.X ±0.30 X.XX ±0.25 X.XXX ±0.15 X.* ±2* X.X* ±0.5* UNIT: mm [inch] SCALE: 1:1 SIZE: A4	DRAWN BY : 陈一鸣	DATE : 2014-02-23	PART NAME: DP 2.1 SMT 有耳 螺丝孔11.3 镀镍 (Support DP UHBR20, For Type 1 Footprint)
	CHECKED BY: 马跃	DATE : 2014-02-23	PART NO. : HVC57-DP20-113
	APPROVED BY: 邱敏	DATE : 2014-02-23	DRAW NO. : HVC-2603301518
			SHEET NO. : 1 OF 1

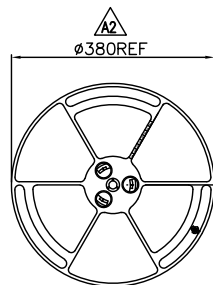
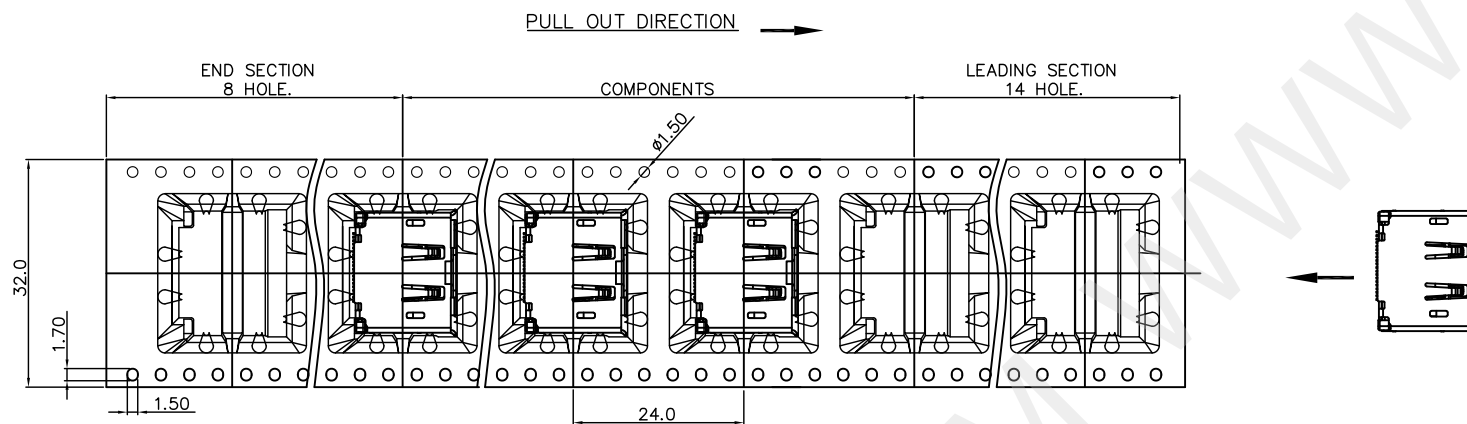

REEL FOR CARRIER TAPE

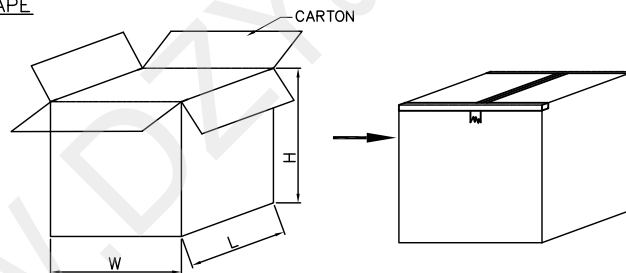
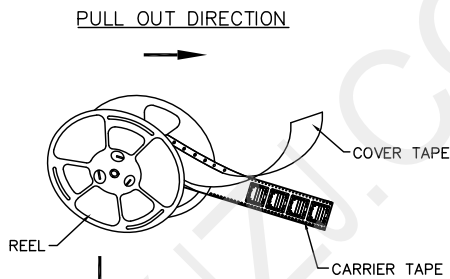

TAPE & REEL PACKAGE :

MATERIALS

1. CARRIER TAPE: POLYSTYREN (PS)
2. COVER TAPE: POLYSTYREN (PS)
3. REEL: POLYSTYREN (PS)

QUANTITY

1. 200PCS PER REEL
2. 10 REEL PER CARTON(2000PCS PER CARTON)  
(CARTON :L=400mm, W=400mm, H=400mm)

 <b>深圳市华宇创精密电子有限公司</b>				
<b>TOLERANCE:</b> X.X ±0.30 X.XX ±0.25 X.XXX ±0.15 X.* ±2*    X.X* ±0.5*	<b>DRAWN BY :</b> 陈一鸣	<b>DATE :</b> 2014-02-23	<b>PART NAME:</b> 包装图	
	<b>CHECKED BY:</b> 马跃	<b>DATE :</b> 2014-02-23	<b>PART NO.</b>	
UNIT: mm [inch] SCALE: 1:1    SIZE: A4	<b>APPROVED BY:</b> 邱敏	<b>DATE :</b> 2014-02-23	<b>MOLD NO.</b>	
			<b>DRAW NO:</b>	
			<b>SHEET NO.</b>	1 OF 1